

Phased Array Probes & Wedges



SIUI



SIUI can Provide a Variety of Probes for Different Kinds of Inspections

Custom Phased Array Probes



Flexible Probe

Low-profile Probe

Matrix Array Probe

Near-Wall Probe

SIUI can produce custom phased array probes to suit specific applications and geometries.

For custom probe, please provide following info:

- Frequency
- Number of elements, pitch and elevation
- Probe type (angle beam, immersion, integrated wedge, matrix)
- Array shape (flat, curve)
- Cable jacket required
- Cable length
- Connector type
- Housing and/or dimension constraints
- Application
- Comparable UT single element transducer

Standard Phased Array Probes

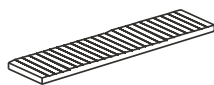

Linear

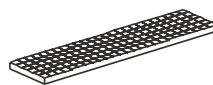

1.5-D array



2-D array

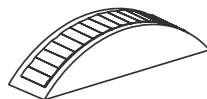

Convex

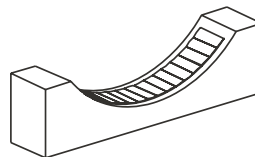

Concave

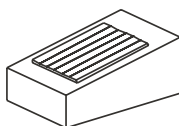

Skewing

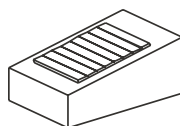

Variable angle

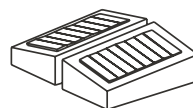

Dual linear

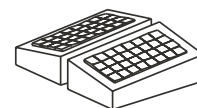

Dual 1.5-D

Ordering Code for Phased Array Probe

7.5L128-0.5-10-N-P-110-2.0-T1

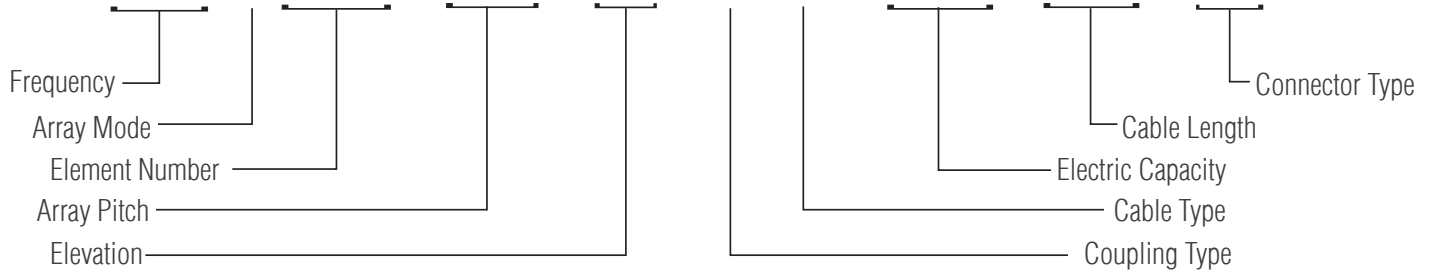

For Example

Frequency

7.5=7.5MHz

Array Mode

L=Linear
C=Convex
V=Concave
M=Matrix

Element Number

128=128 elements

Array Pitch

Unit: mm
0.5=0.5mm

Elevation

Unit: mm
10=10mm

Coupling Type

N is coupled by wedge. **I** is coupled by immersion. **E** is coupled by integrated wedge.

Cable Type

P=PVC wrap
 Metal armor and radiation proof wrap can be provided.

Electric Capacity

Electric capacity each meter.
110=110pF for one meter;
50=50pF for one meter.

Cable Length

Unit: m
2.0=2 meters

Connector Type

T1= Tyco TC ZIF 260P
P1=Omni Connector
H1=Hypertronics
D1=DL-156P
D2=DL-96P
D5=DL-260P
C1=High Density 78 Way D-Type

Other parameters can be added after the model name following the suffix form in “-”.



D5



P1



T1



C1



H1

SIUI can provide PA probes with different connectors compatible with PA equipments from other manufacturers.

Universal Probes

Small/ Medium/ Large-Size & Low Frequency Probes

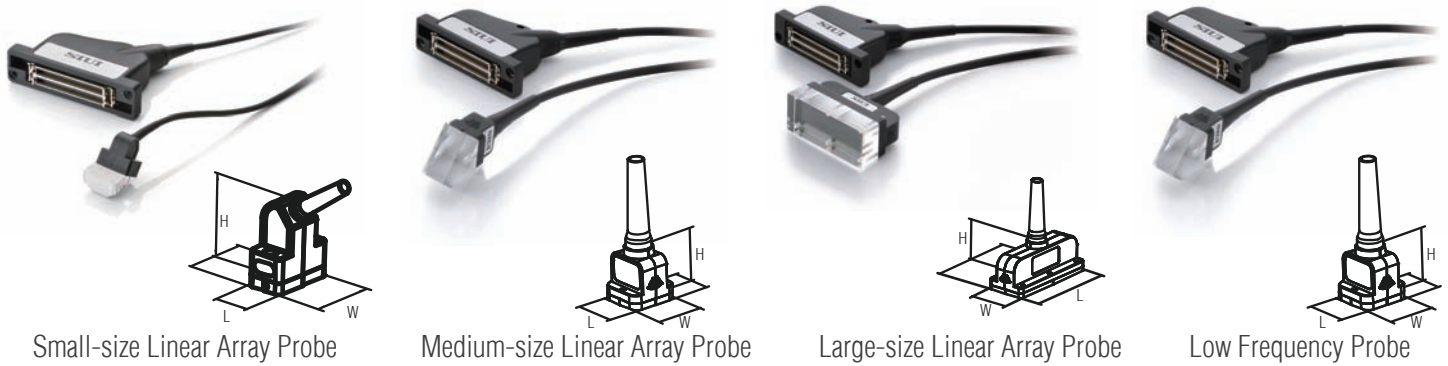

Small-size Linear Array Probe

Medium-size Linear Array Probe

Large-size Linear Array Probe

Low Frequency Probe

Superior Features:

Sound Beam angle, focusing and scan step can be electronically controlled;
 Wide scan coverage can be achieved by one single probe;
 Replaceable angle wedge and delay block, with customizable surface curvature;
 Array pitch and elevation can be customized.

Typical Application

- Small-size Linear Array Probe
--good for inspection on limited space;
- Medium-size Linear Array Probe
--suitable for a wide range of applications;
- Large-size Linear Array Probe
--inspections of cracks on plate-type pieces;
- Low Frequency Probe
--inspection on thick plates or noisy or granular material.

Probe Model	Frequency	Number of elements	Pitch	Active aperture	Housing Dimension (mm)		
	MHz		mm	mm	L	W	H
Small-size Linear Array Probe							
2.5L8-1.0-9	2.5	8	1	8	15	28	28
4.0L16-0.5-9	4	16	0.5	8	15	28	33.5
5.0L16-0.5-9	5	16	0.5	8	15	28	33.5
5.0L16-0.6-10	5	16	0.6	9.6	17	28	33.5
7.5L16-0.5-9	7.5	16	0.5	8	15	28	33.5
10L16-0.5-9	10	16	0.5	8	15	28	33.5
Medium-size Linear Array Probe							
2.5L16-1.0-10	2.5	16	1	16	28	31	33
5.0L32-0.5-10	5	32	0.5	16	28	31	33
5.0L32-0.6-10	5	32	0.6	19.2	32	31	33
7.5L32-0.5-10	7.5	32	0.5	16	28	31	33
Large-size Linear Array Probe							
5.0L64-1.0-10	5	64	1	64	84	36	36
5.0L64-0.5-10	5	64	0.5	32	45	31	33
5.0L64-0.6-10	5	64	0.6	38.4	52	31	33
5.0L128-0.5-10	5	128	0.5	64	84	36	36
7.5L64-1.0-10	7.5	64	1	64	84	36	36
7.5L128-0.5-10	7.5	128	0.5	64	84	36	36
Low Frequency Probe							
2.0L32-1.0-10	2	32	1	32	45	31	33
1.5L16-2.0-10	1.5	16	2	32	45	31	45

The probes are equipped with standard 2m cable.

Immersion Probes



Small-size immersion curved array probe



Large-size immersion curved array probe

Immersion Linear Array Probe

Superior Features:

Sound Beam angle, focusing and scan step can be electronically controlled;
Wide scan coverage can be achieved by one single probe;
*Probe size and outer housing can be customized.

Typical Application:

Suitable for underwater inspection;
Inspection of thin plate or tubing (steel, aluminum, or other);
Composite inspection for delamination;
Inline thickness gaging;
Automated scanning.

Immersion Curved Array Probe(Customized)

Superior Features:

Adopt immersion method for inspection;
Sound Beam angle, focusing and scan step can be electronically controlled;
Wide scan coverage can be achieved by one single probe;
The curvature radius of curved probes can be customized;
*Different parameters can be customized.

Typical Application:

Suitable for underwater inspection;
Inspection of tubing;
Inspection of carbon fiber reinforced polymers (CFRP) corners;
Inspection of composite materials for delamination.

Probe Model	Frequency	Number of elements	Pitch	Active aperture
	MHz		mm	mm
Immersion Linear Array Probe				
5.0L64-0.6-10-I	5	64	0.6	38
5.0L64-1.0-10-I	5	64	1	64
7.5L128-0.39-6-I	7.5	128	0.39	50
7.5L128-0.6-6-I	7.5	128	0.6	76.8
2.0L64-0.6-10-I	2.0	64	0.6	64
Immersion Curved Array Probe				
3.5V128-0.6-10-R65-I	3.5	128	0.6	/
3.5V64-1.6-12-R65-I	3.5	64	1.6	/
5.0V64-1.0-10-R40-I	5.0	64	1.0	/
10.0V128-0.6-10-R40-I	10.0	128	0.6	/

The probes are equipped with standard 2m cable.
Housing dimension can be customized.

Usage Note: The probe should not be submerged for use over 8 hours. Then keep the probe in dry air for at least 16 hours (in non-operated state) until it is naturally dry before re-use.
If the operating time is shortened, the placement period for natural dry can be decreased properly, so as to ensure the normal life of the probe.

High Penetration Probe & Small Footprint Probe

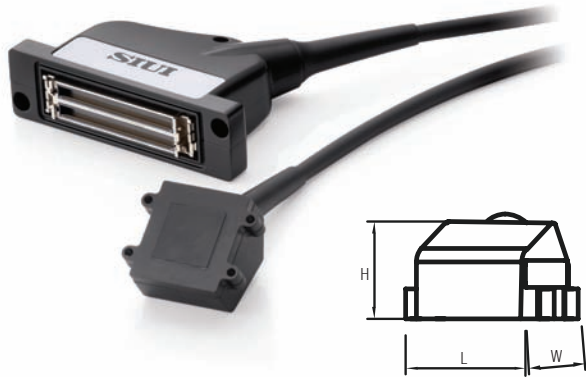

High Penetration Probes

Superior Features:

Good resolution and high penetration;
 Replaceable angle wedge and delay block, with customizable surface curvature;
 Array pitch and elevation can be customized.

Typical Application:

Detection of flaws and sizing;
 Inspections of defects in forgings;
 Inspection on noisy or granular material.

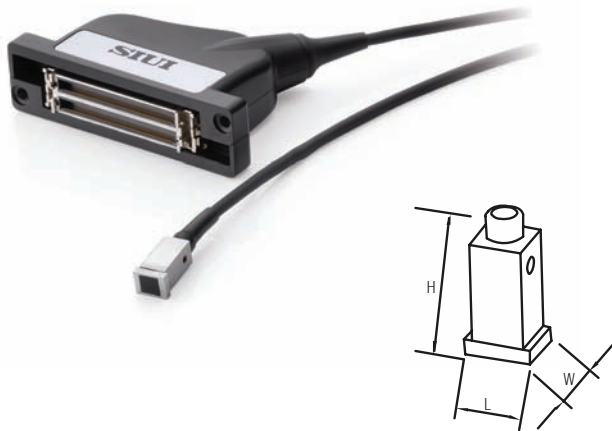

Small Footprint Probe

Superior Features:

Compact size;
 Cable connector can come out from either the side or the top;
 Replaceable angle wedge and delay block, with customizable surface curvature;
 Array pitch and elevation can be customized.

Typical Application:

Inspection on limited space;
 Detection of flaws and sizing;
 Inspection on reduced probe access, or with surfaces with complex geometry.

Probe Model	Frequency	Number of elements	Pitch	Active aperture	Housing Dimension (mm)		
	MHz		mm	mm	L	W	H
High Penetration Probe							
2.5L16-1.2-20	2.5	16	1.2	19.2	40	48	29
5.0L32-0.6-20	5	32	0.6	19.2	40	48	29
Small Footprint Probe							
5.0L10-0.6-6	5	10	0.6	6	13	10	23
7.5L10-0.6-6	7.5	10	0.6	6	13	10	23
10.0L10-0.6-6	10.0	10	0.6	6	10	10	23

The probes are equipped with standard 2m cable.

Wedge for Phased Array Probe

Superior Features:

- Variable angles in steel for selection.
- Wedges with different specifications can be made.
- Compatible with crawler.
- Anti-wear structure design are available.
- Wedges with curvature can be made on request.

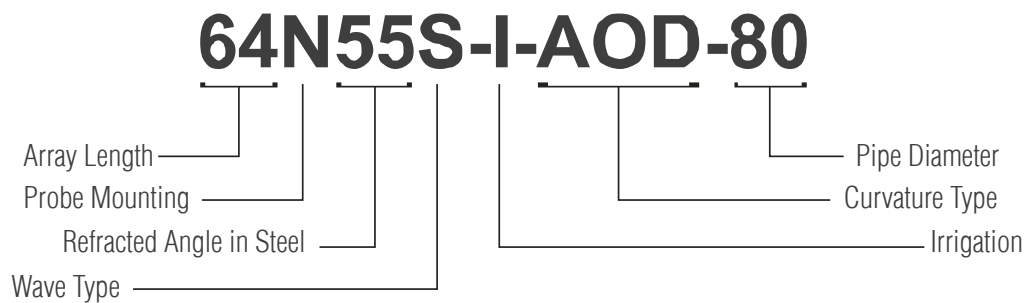
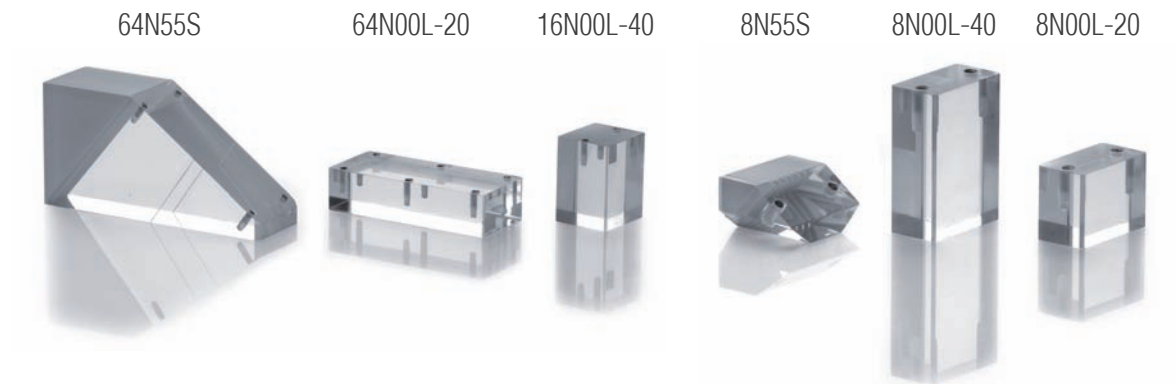

For Example

Active Aperture

64=Compatible phased array probe is 64mm.

Active Aperture= Pitch × Elements

Probe Mounting

N=Normal

L=Skew (in lateral direction)

Refracted Angle in Steel

55=55°

Wave Type

S=Shear wave in steel

L=longitudinal wave in steel

Irrigation

I=Irrigation

Note: without "I" is non-irrigation

Curvature Type

AOD, COD, AID, CID are available.

AOD=Axial outside diameter

COD=Circumferential outside diameter

AID=Axial inside diameter

CID=Circumferential inside diameter

Pipe Diameter

Pipe diameter in mm.

AOD and COD is the outside diameter.

AID and CID is the inside diameter.

80=80mm

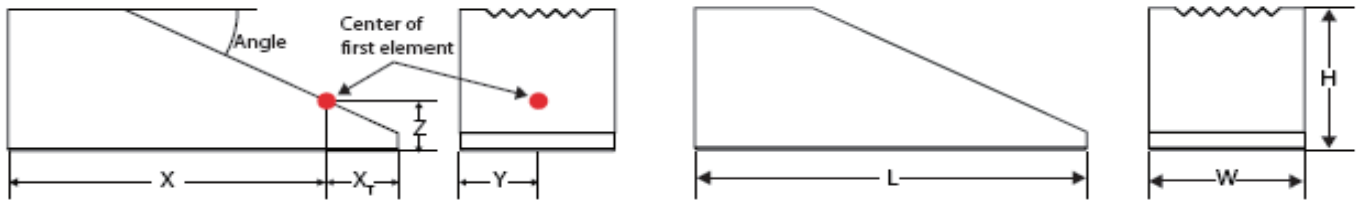

Wedge Model	Description	X	XT	Z	Velocity	Refracted Ang	L	W	H
		mm	mm	mm	m/s		mm	mm	mm
Standard Wedge									
64N00L-20	20mm delay block	73.5	10.5	20	2360	0°	84	35.6	20
64N00L-40	40mm delay block	73.5	10.5	40	2360	0°	84	35.6	40
64N55S	30-70° shear wave angle block	108.67	8.93	14.48	2360	55°	117.6	36	58.5
16N00L-20	20mm delay block	21.75	6.25	20	2360	0°	28	31	20
16N00L-40	40mm delay block	21.75	6.25	40	2360	0°	28	31	40
16N55S	30-70° shear wave angle block	34.94	5.06	9.74	2360	55°	40	31	22.5
8N00L-20	20mm delay block	11.25	3.75	20	2360	0°	15	28	20
8N00L-40	40mm delay block	11.25	3.75	40	2360	0°	15	28	40
8N55S	30-70° shear wave angle block	21.69	3.31	8.4	2360	55°	25	28	15
40N00L-20	20mm delay block	44.9	7.1	20	2360	0°	52	31	20
40N00L-40	40mm delay block	44.9	7.1	40	2360	0°	52	31	40
40N55S	30-70° shear wave angle block	73.24	7.76	13.64	2360	55°	81	31	41.5
32N00L-20	20mm delay block	38	7	20	2360	0°	45	31	20
32N00L-40	40mm delay block	38	7	40	2360	0°	45	31	40
32N55S	30-70° shear wave angle block	64.44	7.56	13.49	2360	55°	72	31	37.5
20N00L-20	20mm delay block	25.3	6.7	20	2360	0°	32	31	20
20N00L-40	40mm delay block	25.3	6.7	40	2360	0°	32	31	40
20N55S	30-70° shear wave angle block	52.58	5.42	18.94	2360	55°	58	31	35.5
10N00L-20	20mm delay block	13	4	20	2360	0°	17	28	20
10N00L-40	40mm delay block	13	4	40	2360	0°	17	28	40
10N55S	30-70° shear wave angle block	27.26	3.24	8.35	2360	55°	30.5	28	17.5

High Temperature Wedge

High temperature wedge enables testing on surface up to 200 °C.
Maximum contact time is 10 seconds.
Cool to ambient before reuse.

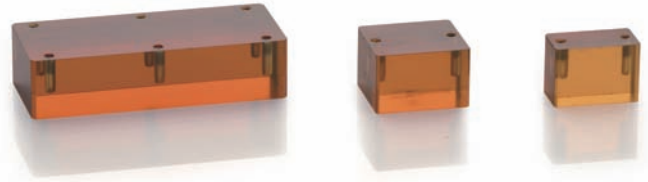

Wedge Model	Description	X	XT	Z	Velocity	Refracted Ang	L	W	H
		mm	mm	mm	m/s		mm	mm	mm
High Temperature Wedge									
64N00L-20-H	20mm Delay Block	73.5	10.5	20	2590	0°	84	35.6	20
64N00L-40-H	40mm Delay Block	73.5	10.5	40	2590	0°	84	35.6	40
16N00L-20-H	20mm Delay Block	21.75	6.25	20	2590	0°	28	31	20
16N00L-40-H	40mm Delay Block	21.75	6.25	40	2590	0°	28	31	40
8N00L-20-H	20mm Delay Block	11.25	3.75	20	2590	0°	15	28	20
8N00L-40-H	40mm Delay Block	11.25	3.75	40	2590	0°	15	28	40
40N00L-20-H	20mm Delay Block	44.9	7.1	20	2590	0°	52	31	20
40N00L-40-H	40mm Delay Block	44.9	7.1	40	2590	0°	52	31	40
32N00L-20-H	20mm Delay Block	38	7	20	2590	0°	45	31	20
32N00L-40-H	40mm Delay Block	38	7	40	2590	0°	45	31	40
20N00L-20-H	20mm Delay Block	25.3	6.7	20	2590	0°	32	31	20
20N00L-40-H	40mm Delay Block	25.3	6.7	40	2590	0°	32	31	40
10N00L-20-H	20mm Delay Block	13	4	20	2590	0°	17	28	20
10N00L-40-H	40mm Delay Block	13	4	40	2590	0°	17	28	40

Curved Wedge

All the wedge models available now can be customized with curvature.

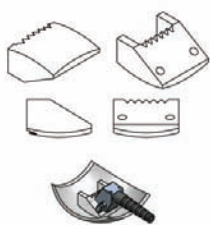

SPHERICAL INSIDE DIAMETER

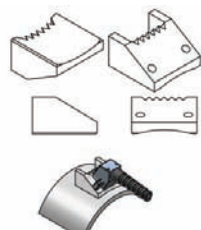

AXIAL OUTSIDE DIAMETER

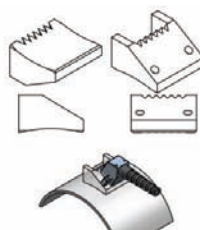

CIRCUMFERENTIAL OUTSIDE DIAMETER

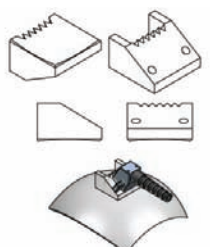

SPHERICAL OUTSIDE DIAMETER

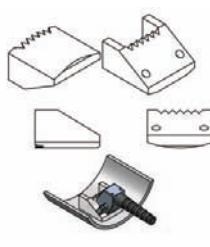

AXIAL INSIDE DIAMETER

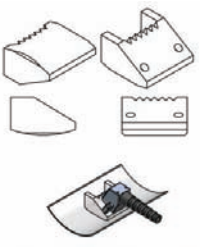

CIRCUMFERENTIAL INSIDE DIAMETER



Irrigation Wedge

Water is used as couplant;
 Suitable for automatic inspection.
 Conventional wedges with surface curvature can be made based on requirement.

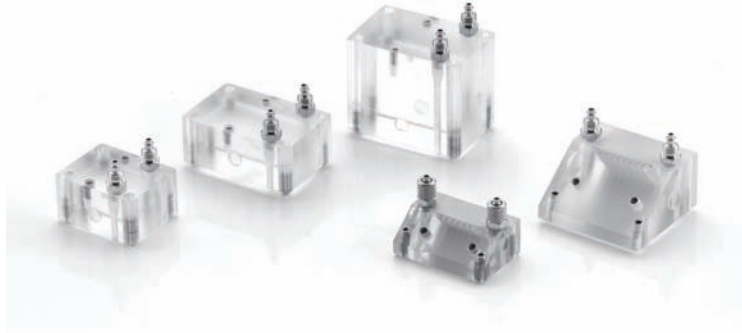

Wedge Model	Description	X	XT	Z	Velocity	Refracted Ang	L	W	H
		mm	mm	mm	m/s		mm	mm	mm
Irrigation Wedge									
8N55S-I	30-70° shear wave angle block	21.69	3.31	8.4	2360	55°	25	39	15
8N00L-20-I	20mm Delay Block	25.25	9.75	20	2360	0°	35	28	20
8N00L-40-I	40mm Delay Block	25.25	9.75	40	2360	0°	35	28	40
16N55S-I	30-70° shear wave angle block	34.94	5.06	9.67	2360	55°	40	43	22.5
16N00L-20-I	20mm Delay Block	43.5	4.5	20	2360	0°	48	31	20
16N00L-40-I	40mm Delay Block	43.5	4.5	40	2360	0°	48	31	40

Crawler for Phased Array

Different crawlers compatible with PA probes can be provided by SIUI.



Example of Phased Array Probe Test Report

Probe:5.0L64-1.0-10
Serial Number:*****

Probe Information

Frequency: 5.0MHz
Probe Type: Linear Array
Element Count: 64
Cable Length: 2.0M

Active Area Dimension

Length: 64mm
Elevation: 10mm
Pitch: 1.0mm
Matching Medium: Rexolite

Probe Conformance Summary

Overall Vp-p Sensitivity: 2.39dB (≤ 3 dB)
Average Center Frequency: 5.13MHz(5.0MHz \pm 10%)
Average -6dB Bandwidth: 78.46%(≥ 60 %)

Probe Test Condition

Instrument Model: 5052UA
Pulse Voltage: 120V
Pulse Type: Negative
Dumping: 50ohm
Energy: 1
Target Medium: Rexolite
Target Type: 25.4mm Plate

Probe Test Result

Parameters	Unit	Min	Max	Mean
Peak-Peak Sensitivity	dB	-47.61	-45.22	-46.79
-20dB Pulse Length	nS	582.4	636	605.23
-6dB Center Frequency	MHz	5.07	5.25	5.13
-6dB Bandwidth	%	74.59	80.39	78.46

Probe Test Graph

1. Element Waveform:

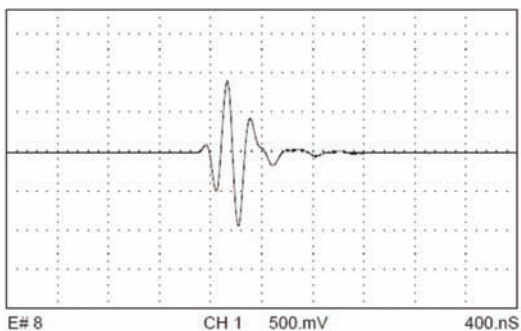

2. Element Waveform FFT:

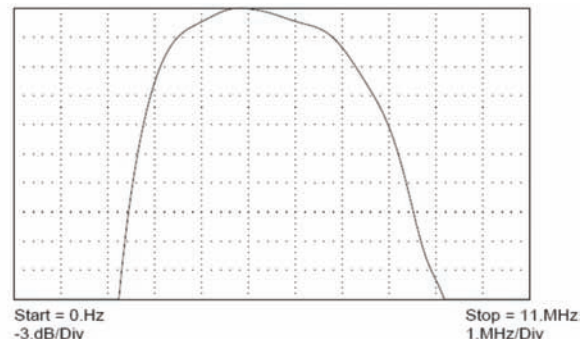

SIUI can Provide

A series of phased array probes compatible with different phased array flaw detectors;
Customization of phased array probes and wedges with different specifications.



SIUI

Shantou Institute of Ultrasonic Instruments Co., Ltd.

Add: #77, Jinsha Road, Shantou 515041, Guangdong, China

Tel: +86-754-88250150 **Fax:** +86-754-88251499

E-mail: siui@siui.com **Website:** <http://www.siui.com>

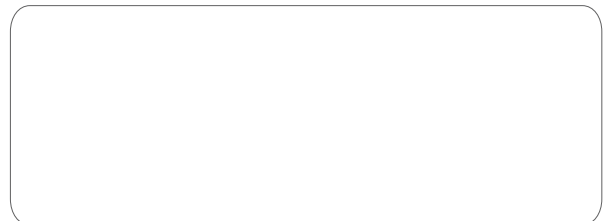

Specifications and appearance are subject to change without prior notice.
DCY2.791.PA Probes.CY/7D03