

THE CR SPECIALISTS

HD-CR/CR 35 NDT

COMPUTED RADIOGRAPHY SYSTEMS



Digital Intelligence - Ready to Change.
www.duerr-ndt.com



VERSATILE AND DEPENDABLE

HIGH-TECH MADE IN GERMANY



Highest resolution

DÜRR NDT is the only manufacturer worldwide to offer 30 micron basic spatial resolution (SR_b), BAM certified*

Flexible formats

Able to process imaging plates of all sizes and quality grades as well as shapes specific to a workpiece



Universal

Perfectly suited to the diverse tasks of radiographic inspection, including to ISO, ASTM and ASME standards

Extremely low maintenance

Only minor servicing required every 2 years even if used in dirty and dusty environments

Portable & compact

At just 17.5 kg, is the lightest and most compact full-format scanner (27.5 kg incl. transport case)

High throughput

Several imaging plates can be scanned simultaneously

Intuitive software

The DICONDE compliant D-Tect software assists you in image evaluation, thus maximizing your workflow

No darkroom needed

Special imaging plate accessories are available to protect from light when used in daylight conditions

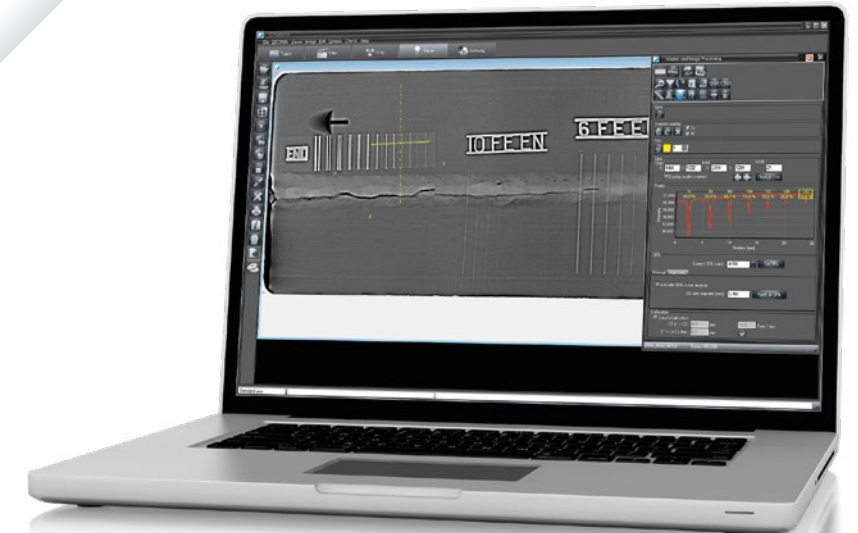

Computed radiography (CR) is the digital replacement of conventional X-ray film radiography and offers enormous advantages for inspection tasks - the use of consumables is virtually eliminated and the time to produce an image is drastically shorter.

How does CR work?

1. Instead of film, an imaging plate is exposed to X-ray or gamma radiation.
2. The plate is digitized by the scanner and then erased for immediate reuse.
3. The digital image is then displayed on a computer monitor for evaluation.

Advantages of CR

- ✓ Substantial cost savings as imaging plates are reusable up to 1000 times (or more, depending on the application)
- ✓ Considerable reductions in exposure time
- ✓ Software-based evaluation and reporting
- ✓ Digital archiving
- ✓ More details visible and analyzable
- ✓ No darkroom or chemicals needed
- ✓ Safer for operators and the environment

*HD-CR 35 NDT

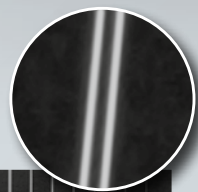

SYSTEMS FOR EVERY CR APPLICATION

DEVELOPED FOR THE HIGHEST QUALITY DEMANDS

Whether for a portable application in the field or as part of the production process, with the HD-CR 35 NDT you have peace of mind, now and in the future. This is because its unique TreFoc Technology allows the widest range of applications and the highest resolution of all CR scanners. While the CR 35 NDT without TreFoc is more than capable of performing erosion and corrosion inspections.

Standalone operation

Complete control of the device is possible using the touchscreen.

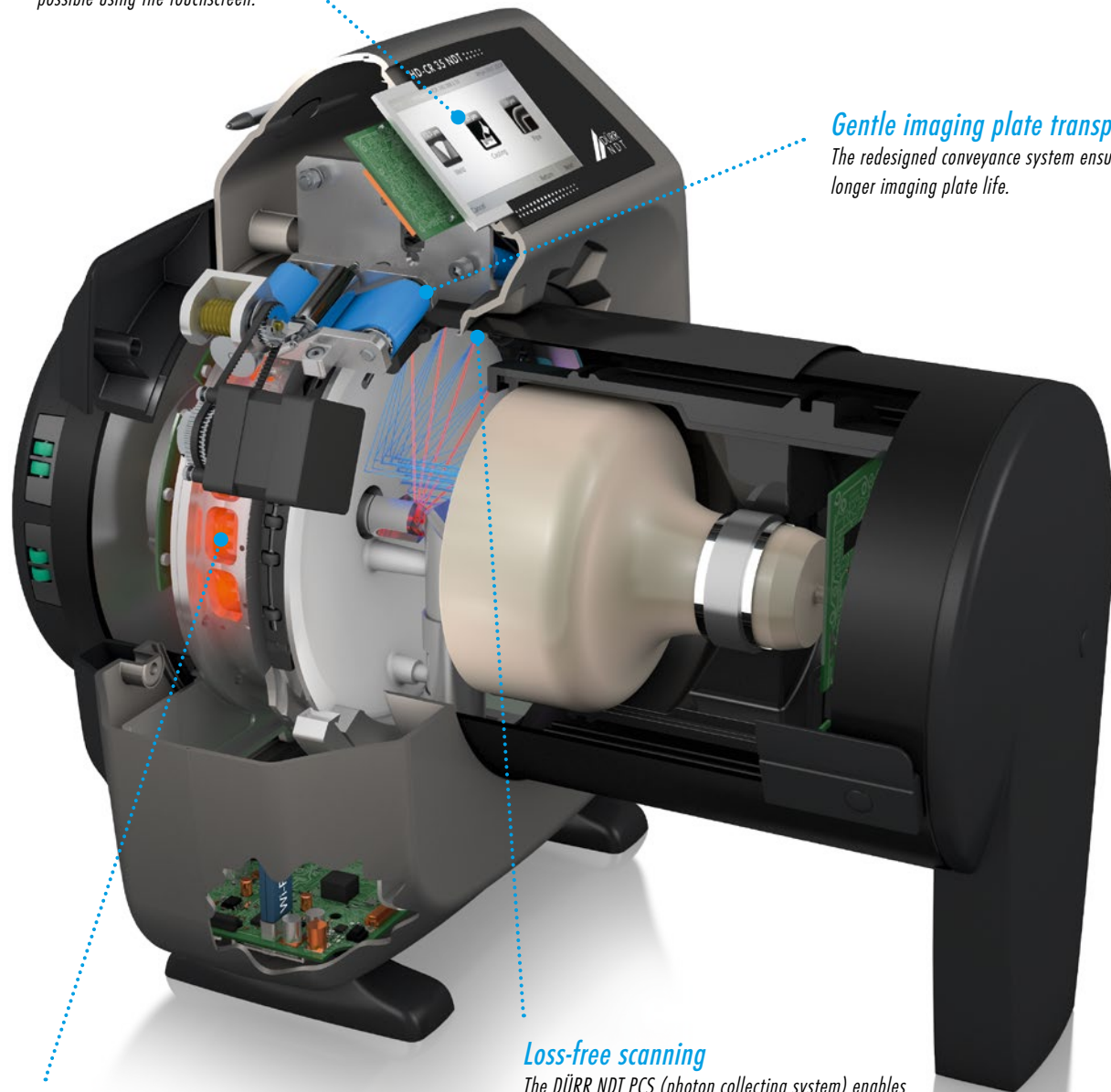

Gentle imaging plate transport

The redesigned conveyance system ensures longer imaging plate life.

Diverse range of applications

- Oil & gas
- Aerospace
- Automotive
- Power stations
- Research and testing
- Military
- Museums
- Special applications

Loss-free scanning

The DÜRR NDT PCS (photon collecting system) enables maximum utilization of the information in the imaging plate by scanning without any loss.

LED erasing unit

After scanning, high-performance LEDs efficiently erase all information in the imaging plate so they can be immediately reused.

TreFoc Technology¹

Developed by DÜRR NDT, this technology adjusts the laser beam size in order to provide the optimum image result with the highest signal-to-noise ratio for the specific task at hand.

Future-proofed with the highest resolution¹

With certified 30-micron basic spatial resolution, even the tiniest defects are easily identified. At the same time you are also equipped for the more exacting requirements of the future.

Individually adjustable

The pre-configured scan modes can be easily modified or new ones added to suit your particular application.

High efficiency

Scanning several image plates simultaneously with automatic cropping and saving makes it possible to increase throughput.

Imaging plate compatibility

It is possible to scan imaging plates of all sizes and quality grades, even with shapes specific to a workpiece, from 2 cm in width and up to 100 cm in length.

Robust and durable

The scanning system is tried and tested with over 100,000 sold to-date. Further peace of mind is provided by the 5-Year Guarantee². The scanner works flawlessly even in dirty and dusty environments.

Consistent image quality

Using a special imaging reference object, the system can be quickly qualified to the latest standards. The separately available CR-Phantom also contains instructions for carrying out the qualification process.

Expertise

The scanner not only provides you with a CR system, but also a solution to your

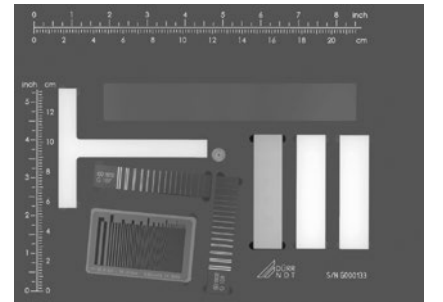

Test image of the DÜRR NDT CR-Phantom

specific inspection problem. Providing you with presales expert advice and assisting you until you achieve the perfect workflow is just as important to us and our partners as giving you fast and professional service support. At our Training Academy we also make sure that our customers are able to fully exploit the potential and advantages of our systems.

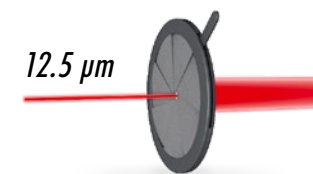

12.5 µm
Weld inspection, aerospace, composite materials

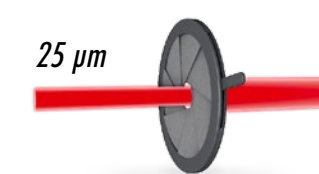

25 µm
Weld inspection, metal casting, isotope applications

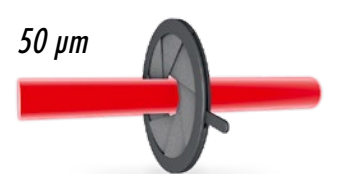

50 µm
Corrosion measurements, overview radiographs, isotope applications



TreFoc
TECHNOLOGY

¹HD-CR 35 NDT, ²see guarantee conditions at www.duerr-ndt.com

THE PERFECT SOFTWARE SOLUTION

IDENTIFY RISKS QUICKLY WITH DÜRR NDT D-TECT

D-Tect allows you to achieve an optimal and time-saving inspection workflow. All necessary functions are included: from image capture, analysis and report generation to data import/export and database management.

Despite its comprehensive set of features, D-Tect is fast, intuitive and easy-to-learn. Support for the DICOM standard ensures that images can be viewed and processed by any other DICOM compatible system. The D-Tect Enterprise integration solution also provides the possibility to interface with nearly any third-party software or system.

Key functions

- DICOM interface
- Automatic network database synchronization after field work
- Extensive export functions
- Simultaneous reference image adjustment
- Automatic DICOM import
- Automatic filter settings for defined applications

Other features

- Region of interest (ROI) histogram
- SNR and CNR calculation
- SR_b determination
- Wall thickness measurement
- Image filters to assist with evaluation
- Radiographed material thickness
- Angle and length measurement
- Text and graphic elements
- Image comments/annotations
- Extensive cropping functionality
- Line profile display
- Report generation

Network integration

In addition to normal single-workstation use, the software can be effortlessly integrated into a network if a collaborative workflow is required. It is also possible to interface with external cloud solutions.

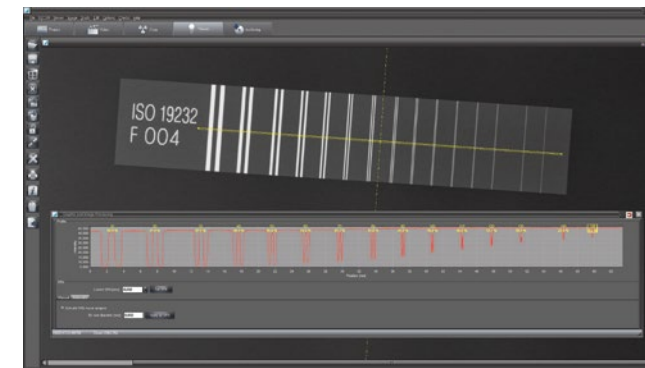
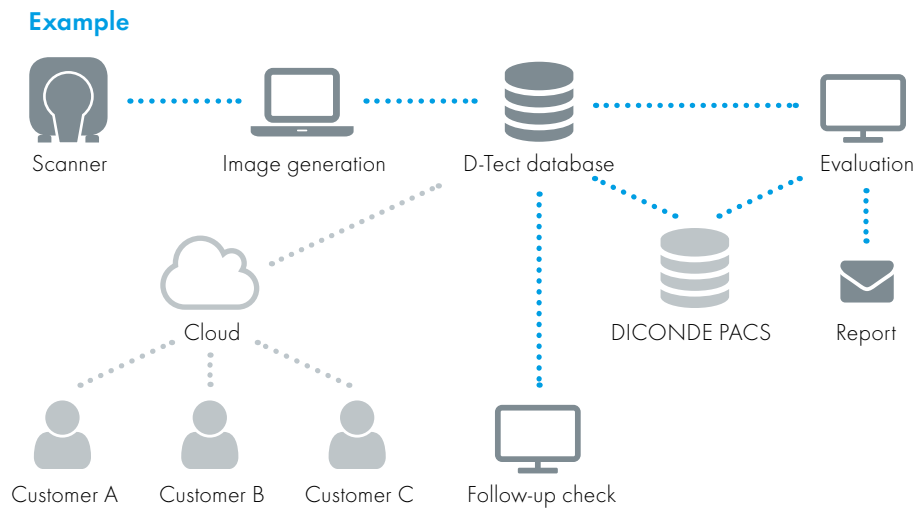

Basic spatial resolution (SR_b)

After loading an image, the SR_b is automatically determined according to ISO 17636-2 and ASTM E 2446 by drawing a line over a duplex wire (IQI).

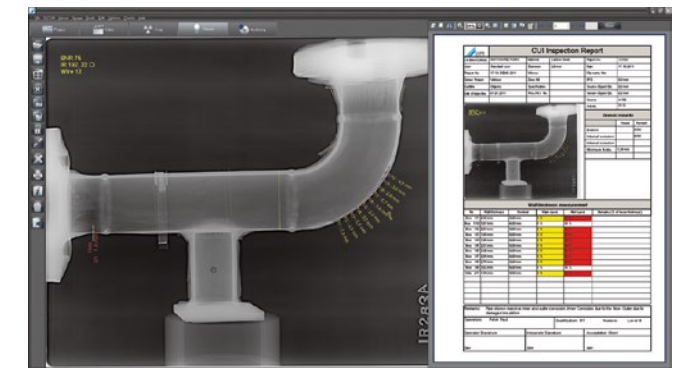

Report function

In a few easy steps, a comprehensive report can be generated from the project data. Custom templates can also be created.

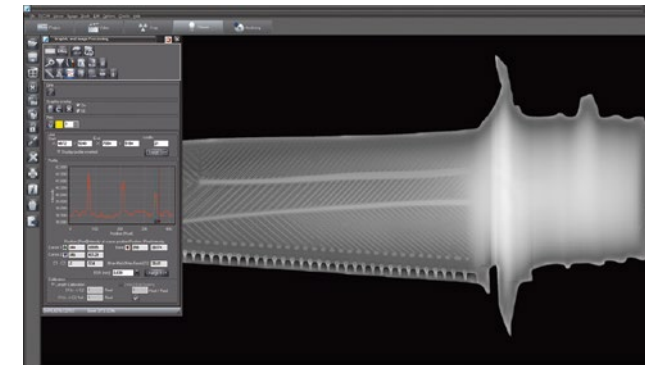

Simple and reliable evaluation

Consistent quality and detection of the finest details are essential for NDT - specially designed filters and functions make simple and effective evaluation possible. With only three clicks it is possible to save optimum evaluation settings for use with subsequent images.

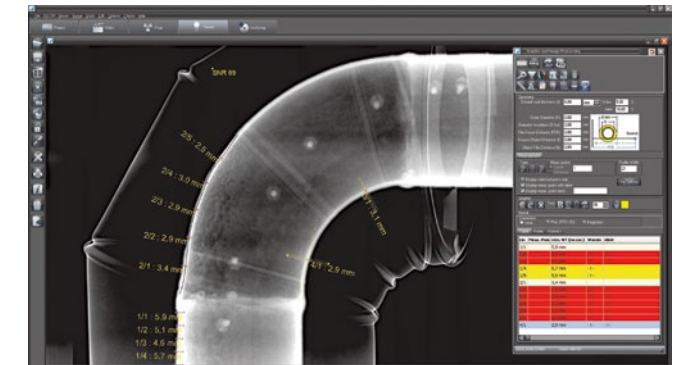

Wall thickness measurement

This optional tool measures the thickness at one or more points along the straight or curved walls of a pipe. Limits can be defined so that warnings are shown when the wall thickness becomes critically thin. All the latest standards requirements are also taken into account.

WORKFLOW

STANDARD OPERATION



1 Position imaging plate(s) and expose

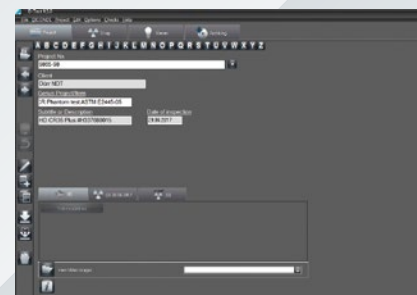

2 Select an existing project or create a new one

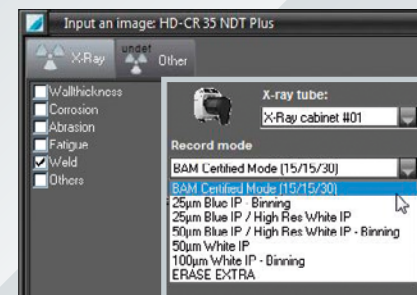

3 Select the desired application and scan mode

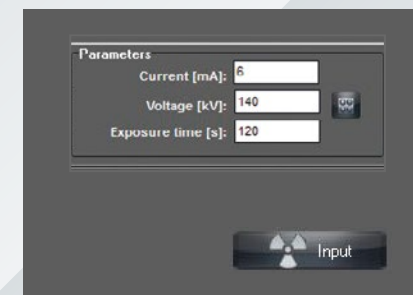

4 Enter X-ray parameters (recommended) and start the scan



5 Feed in the imaging plate(s) - intake then starts automatically

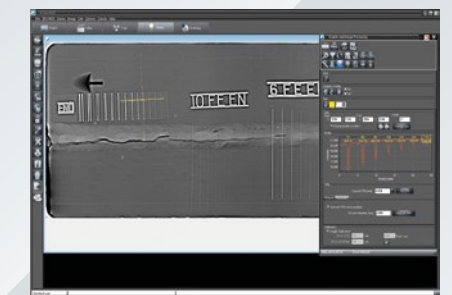

6 Examine the image(s) or forward them for examination

Technical data

HD-CR 35 NDT

CR 35 NDT

Laser spot size	12.5 - 25 - 50 µm, TreFoc Technology	50 µm
SR_b (basic spatial resolution)	30 µm, BAM certified*	80 µm
Grayscale resolution	16-bit (65,536 gray levels)	
Min./Max. imaging plate size (W x L)	2 to 35 cm x 3 to 100 cm (0.8 to 14" x 1.2 to 40")	
Dimensions (H x W x D)	40 x 37 x 47 cm (15.8 x 14.6 x 18.5")	
Weight	17.5 kg (38.6 lbs)	
Power supply	100 - 240 VAC / 50 - 60 Hz, < 140 W	
Operating conditions	10 to 35°C (50 to 95°F)	
Noise level	< 39 dB(A)	
Interfaces	Ethernet, WLAN	
Touchscreen	4.3" TFT, 800 x 480 px	
Internal storage	SDHC, max. 32 GB	
Software	DÜRR NDT D-Tect (DICONDE compliant to ASTM 2339)	
Imaging plates	High sensitivity, regular definition, high resolution, ultra-high resolution	
Standard formats	6 x 24 cm, 6 x 48 cm, 10 x 24 cm, 10 x 48 cm, 18 x 24 cm, 24 x 30 cm, 30 x 40 cm, 35 x 43 cm, 4.5 x 10", 4.5 x 17", 5 x 7", 8 x 10", further formats and individual shapes available by request	
Accessories	Transport case, DÜRR NDT CR-Phantom, Mobile Power Adapter, feed guides, protectors for imaging plates, and more	

*according to ISO 16371-1, ASTM E 2445, ASTM E 2446

Applications

HD-CR 35 NDT

CR 35 NDT

Weld inspection¹	★★★★★	★★★☆☆
Erosion and corrosion inspection²	★★★★☆	★★★★★
Metal casting³	★★★★★	★★★☆☆
Metal precision casting³	★★★★★	☆☆☆☆☆
Composites	★★★★★	☆☆☆☆☆
Arts	★★★★★	★★★☆☆
Concrete inspection	★★★★☆	★★★★★
Crystal structure analysis	★☆☆☆☆	★★★★★

Also suitable for inspections according to ¹ ISO 17636-2, ASME V, ² EN 16407-1, EN 16407-1, ³ ISO 16371-2